

Data sheet - FH-M3-15

Self-clinching flush head studs

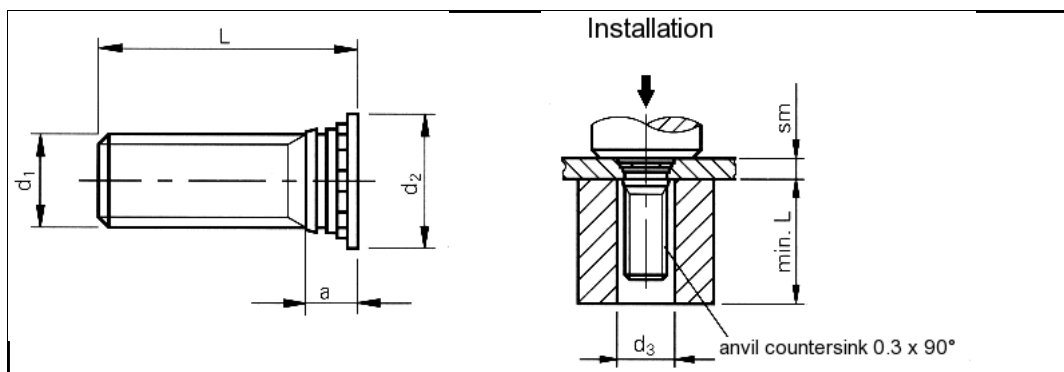

3D-Data available	
Order description	FH-M3-15
Thread d1	M3
Hole-Ø in the sheet +0.08 0	3.0 mm
d2 ±0.4	4.6 mm
d3	3.1 mm
Max. a	2.1 mm
Min. sm	1.0 mm
L ±0.4	15 mm
Min. edge distance up to the hole centre	5.6 mm
Material	Grade 8.8 through-hardened zinc-plated carbon steel.
Use	For sheet hardnesses up to HRB 80.
Information	For thin sheet applications with 0.5 mm use Types TFH (M3 to M5).
Tools	
Insertion machines	

uniform resource locator: